



Svítidlo

Drob-T

177-600S-10GGE/830, B



Naklápěcí lištová svítidla s možností stmívání svým tvarem lehce připomínají reflektory historických vozů. Obsahují vysoce svítící LED s podáním barev $R_a > 80$ či $R_a > 90$, transparentní plexi či satinovaný difuzor. Svítidla používají adaptéry pro tříokruhové lišty Global Track. Díky minimalistickému designu mají nižší světelné toky, a proto jsou vhodná spíše do menších obchodů s nižšími stropy, jako jsou například drogerie nebo lékárny. Svě uplatnění ale mohou najít i v barech nebo méně formálních recepcích.

Technický výkres



Typ montáže	Lištové
Typ vyzařování	Přímé
Tvar svítidla	Kruhové
Barva svítidla	Černá
Materiál	Hliník
Životnost	L80/B20 50 000 hodin
Záruka	5 let
Popis svítidla	Svítidlo lištové
Rozměry	ø 85 mm × 110 mm
Hmotnost	0.45 kg
Světelný zdroj	LED MODUL
Druh optiky	Reflektor
Světelný tok*	2200 lm
Teplota chromatičnosti	3000 K teplá bílá
Měrný výkon	132 lm/W
MacAdam zdroje	3
Index podání barev	80
Vyzařovací úhel	18°
UGR max. X=4H Y=8H, ρ=70,50,20	18.8
Příkon svítidla*	16.7 W
Zapojení svítidla	ON/OFF
Elektrické napětí	220-240V
Frekvence	50/60Hz

 **CE** IP 20

*±10 %

Křivka



Ke stažení[Montážní návod](#)[Fotografie](#)

Příslušenství

00-00300, N
 lankový závěs 2000mm
 -1 ks

00-00301, N
 lankový závěs 4000mm
 -1 ks

00-00302, N
 lankový závěs 6000mm
 -1 ks

00-00363, K
 kabel 5x1,5 2000mm

00-00364, K
 kabel 5x1,5 4000mm

00-00365, K
 kabel 5x1,5 6000mm

00-00370, B
 kališek stropní
 80x80x32mm

00-00370, S
 kališek stropní
 80x80x32mm

00-00370, W
 kališek stropní
 80x80x32mm

SKB10-1, grey
 stropní úchyt pro lištu,
 šedá

SKB10-2, black
 stropní úchyt pro lištu,
 černá

SKB10-3, white
 stropní úchyt pro lištu,
 bílá

SKB12-1, grey
 úchyt do lišty pro
 lankový závěs, šedá

SKB12-2, black
 úchyt do lišty pro
 lankový závěs, černá

SKB12-3, white
 úchyt do lišty pro
 lankový závěs, bílá

XTAK11-1, grey
 háček, šedá

XTAK142-1, grey
 základna háčku, šedá

XTAK142-2, black
 základna háčku, černá

XTAK142-3, white
 základna háčku lanko
 2mm, bílá

XTS11-1, grey
 koncové napájení levé,
 šedá

XTS11-2, black
 koncové napájení levé,
 černá

XTS11-3, white
 koncové napájení levé,
 bílá

XTS12-1, grey
 koncové napájení pravé,
 šedá

XTS12-2, black
 koncové napájení pravé,
 černá

XTS12-3, white
 koncové napájení pravé,
 bílá

XTS14-1, grey
 napájení středové, šedá

XTS14-2, black
 napájení středové, černá

XTS14-3, white
 napájení středové, bílá

XTS21-1, grey
 spojka přímá, šedá

XTS21-2, black
 spojka přímá, černá

XTS21-3, white
 spojka přímá, bílá

XTS24-1, grey
 spojka ohebná kloubová,
 šedá

XTS24-2, black
 spojka ohebná kloubová,
 černá

XTS24-3, white
 spojka ohebná kloubová,
 bílá

XTS34-1, grey
 spojka L vnitřní, šedá

XTS34-2, black
 spojka L vnitřní, černá



XTS34-3, white
spojka L vnitřní, bílá



XTS35-1, grey
spojka L vnější, šedá



XTS35-2, black
spojka L vnější, černá



XTS35-3, white
spojka L vnější, bílá



XTS36-1, grey
spojka T vnější pravá, šedá



XTS36-2, black
spojka T vnější pravá, černá



XTS36-3, white
spojka T vnější pravá, bílá

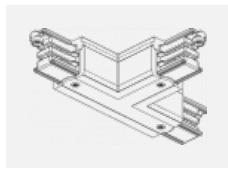

XTS37-1, grey
spojka T vnitřní levá, šedá

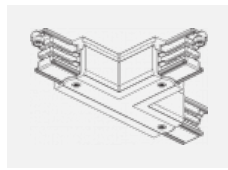

XTS37-2, black
spojka T vnitřní levá, černá

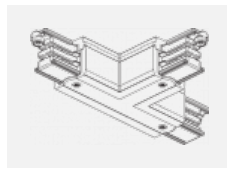

XTS37-3, white
spojka T vnitřní levá, bílá

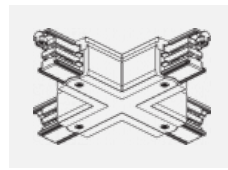

XTS38-1, grey
spojka X, šedá

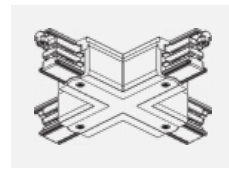

XTS38-2, black
spojka X, černá



XTS38-3, white
spojka X, bílá

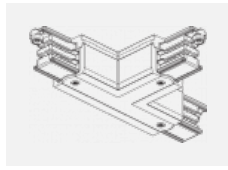

XTS39-1, grey
spojka T vnější levá, šedá

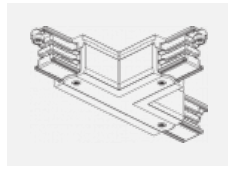

XTS39-2, black
spojka T vnější levá, černá

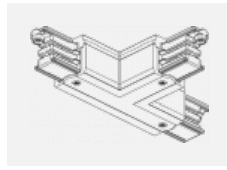

XTS39-3, white
spojka T vnější levá, bílá

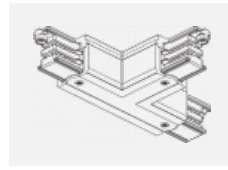

XTS40-1, grey
spojka T vnitřní pravá, šedá

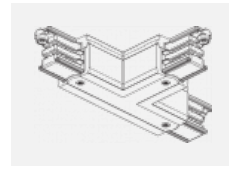

XTS40-2, black
spojka T vnitřní pravá, černá



XTS40-3, white
spojka T vnitřní pravá, bílá

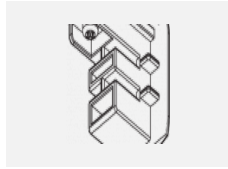

XTS41-1, grey
koncovka, šedá

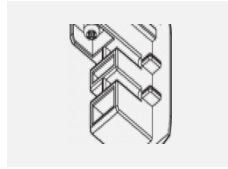

XTS41-2, black
koncovka, černá

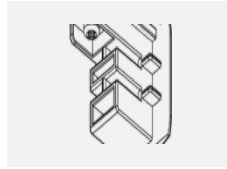

XTS41-3, white
koncovka, bílá

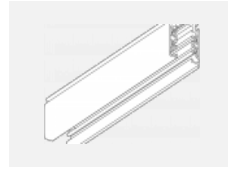

XTS4100-1, grey
lišta 1m, šedá

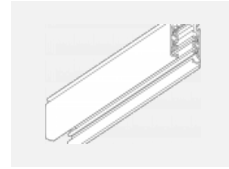

XTS4100-2, black
lišta 1m, černá



XTS4100-3, white
lišta 1m, bílá



XTS4200-1, grey
lišta 2m, šedá



XTS4200-2, black
lišta 2m, černá

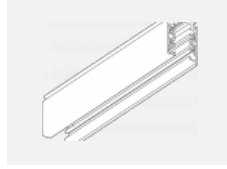

XTS4200-3, white
lišta 2m, bílá

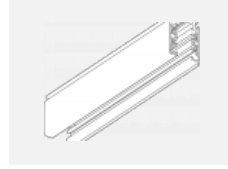

XTS4300-1, grey
lišta 3m, šedá

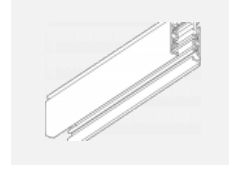

XTS4300-2, black
lišta 3m, černá



XTS4300-3, white
lišta 3m, bílá



XTS4400-1, grey
lišta 4m, šedá



XTS4400-2, black
lišta 4m, černá



XTS4400-3, white
lišta 4m, bílá



XTSF4100-1, grey
lišta 1m - zapuštěná
montáž, šedá



XTSF4100-2, black
lišta 1m - zapuštěná
montáž, černá



XTSF4100-3, white
lišta 1m - zapuštěná
montáž, bílá

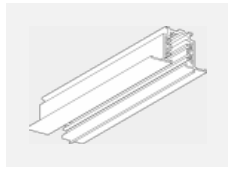

XTSF4200-1, grey
lišta 2m - zapuštěná
montáž, šedá

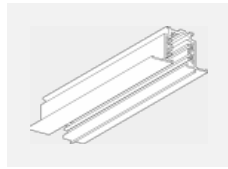

XTSF4200-2, black
lišta 2m - zapuštěná
montáž, černá

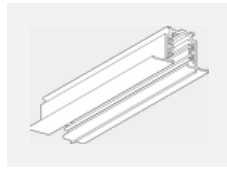

XTSF4200-3, white
lišta 2m - zapuštěná
montáž, bílá

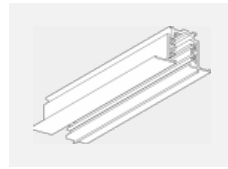

XTSF4300-1, grey
lišta 3m - zapuštěná
montáž, šedá

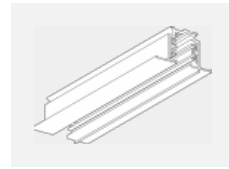

XTSF4300-2, black
lišta 3m - zapuštěná
montáž, černá



XTSF4300-3, white
lišta 3m - zapuštěná
montáž, bílá



XTSF4400-1, grey
lišta 4m - zapuštěná
montáž, šedá



XTSF4400-2, black
lišta 4m - zapuštěná
montáž, černá



XTSF4400-3, white
lišta 4m - zapuštěná
montáž, bílá



XTSV12-1, grey
nástroj na ohýbání
vodičů