



## Svítidlo

# Sant-T

132-600K-25GEE/830, S



Holandský designér Rob van Beek vdechl LED lineárnímu svítidlu s opálovým difusorem světový vzhled. V Čechách jsme pak Sant vyrobili speciálně pro LED zdroje a technologii Human Centric Lighting. Svítidlo Sant-T je vhodné především jako doplňkové osvětlení do obchodních prostor.

Design Rob van Beek

## Technický výkres

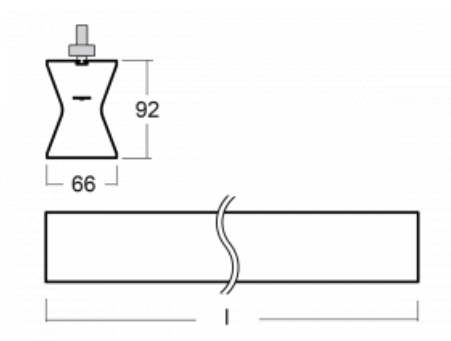

Typ montáže	Lištové
Typ vyzařování	Přímo-nepřímé
Tvar svítidla	Lineární
Barva svítidla	Stříbrná
Materiál	Hliník
Životnost	L80/B20 50 000 hodin
Záruka	5 let
Popis svítidla	Svítidlo lištové
Rozměry	1410 mm × 66 mm × 92 mm
Hmotnost	3.8 kg
Světelný zdroj	LED MODUL
Druh optiky	Opálový difusor
Světelný tok*	2630 lm
Teplota chromatičnosti	3000 K teplá bílá
Měrný výkon	110 lm/W
MacAdam zdroje	3
Index podání barev	80
UGR max. X=4H Y=8H, ρ=70,50,20	21.8
Příkon svítidla*	24 W
Zapojení svítidla	ON/OFF
Elektrické napětí	220-240V
Frekvence	50/60Hz



 IP 20

\*±10 %

# Křivka



**Ke stažení**

Montážní návod



Fotografie



**Příslušenství**

**00-00300, N**  
 lankový závěs 2000mm  
 -1 ks

**00-00301, N**  
 lankový závěs 4000mm  
 -1 ks

**00-00302, N**  
 lankový závěs 6000mm  
 -1 ks

**00-00363, K**  
 kabel 5x1,5 2000mm

**00-00364, K**  
 kabel 5x1,5 4000mm

**00-00365, K**  
 kabel 5x1,5 6000mm

**00-00370, B**  
 kališek stropní  
 80x80x32mm

**00-00370, S**  
 kališek stropní  
 80x80x32mm

**00-00370, W**  
 kališek stropní  
 80x80x32mm

**SKB10-1, grey**  
 stropní úchyt pro lištu,  
 šedá

**SKB10-2, black**  
 stropní úchyt pro lištu,  
 černá

**SKB10-3, white**  
 stropní úchyt pro lištu,  
 bílá

**SKB12-1, grey**  
 úchyt do lišty pro  
 lankový závěs, šedá

**SKB12-2, black**  
 úchyt do lišty pro  
 lankový závěs, černá

**SKB12-3, white**  
 úchyt do lišty pro  
 lankový závěs, bílá

**XTAK11-1, grey**  
 háček, šedá

**XTAK142-1, grey**  
 základna háčku, šedá

**XTAK142-2, black**  
 základna háčku, černá

**XTAK142-3, white**  
 základna háčku lanko  
 2mm, bílá

**XTS11-1, grey**  
 koncové napájení levé,  
 šedá

**XTS11-2, black**  
 koncové napájení levé,  
 černá

**XTS11-3, white**  
 koncové napájení levé,  
 bílá

**XTS12-1, grey**  
 koncové napájení pravé,  
 šedá

**XTS12-2, black**  
 koncové napájení pravé,  
 černá

**XTS12-3, white**  
 koncové napájení pravé,  
 bílá

**XTS14-1, grey**  
 napájení středové, šedá

**XTS14-2, black**  
 napájení středové, černá

**XTS14-3, white**  
 napájení středové, bílá

**XTS21-1, grey**  
 spojka přímá, šedá

**XTS21-2, black**  
 spojka přímá, černá

**XTS21-3, white**  
 spojka přímá, bílá

**XTS24-1, grey**  
 spojka ohebná kloubová,  
 šedá

**XTS24-2, black**  
 spojka ohebná kloubová,  
 černá

**XTS24-3, white**  
 spojka ohebná kloubová,  
 bílá

**XTS34-1, grey**  
 spojka L vnitřní, šedá

**XTS34-2, black**  
 spojka L vnitřní, černá



**XTS34-3, white**  
spojka L vnitřní, bílá

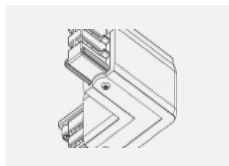

**XTS35-1, grey**  
spojka L vnější, šedá

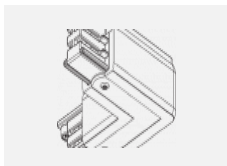

**XTS35-2, black**  
spojka L vnější, černá

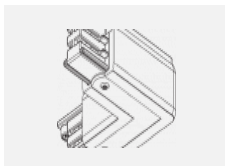

**XTS35-3, white**  
spojka L vnější, bílá

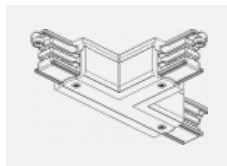

**XTS36-1, grey**  
spojka T vnější pravá,  
šedá

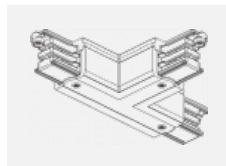

**XTS36-2, black**  
spojka T vnější pravá,  
černá

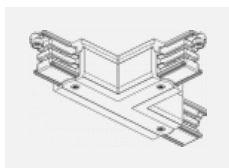

**XTS36-3, white**  
spojka T vnější pravá,  
bílá

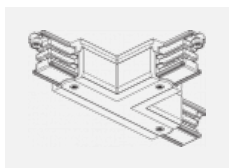

**XTS37-1, grey**  
spojka T vnitřní levá,  
šedá

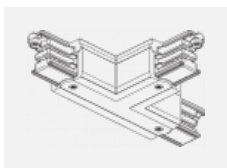

**XTS37-2, black**  
spojka T vnitřní levá,  
černá

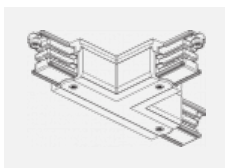

**XTS37-3, white**  
spojka T vnitřní levá, bílá

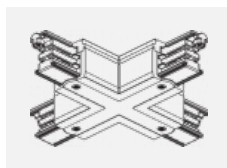

**XTS38-1, grey**  
spojka X, šedá

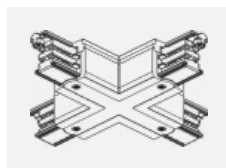

**XTS38-2, black**  
spojka X, černá

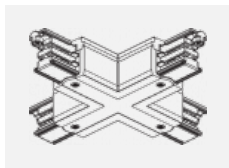

**XTS38-3, white**  
spojka X, bílá

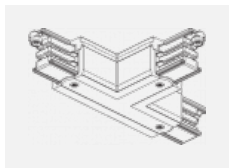

**XTS39-1, grey**  
spojka T vnější levá,  
šedá

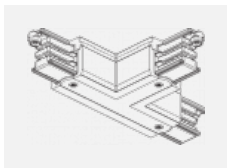

**XTS39-2, black**  
spojka T vnější levá,  
černá

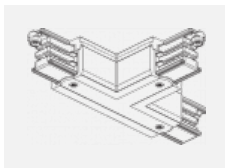

**XTS39-3, white**  
spojka T vnější levá, bílá

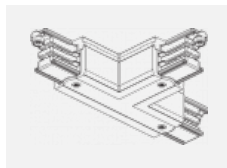

**XTS40-1, grey**  
spojka T vnitřní pravá,  
šedá

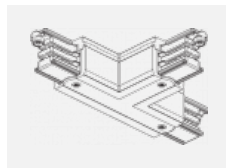

**XTS40-2, black**  
spojka T vnitřní pravá,  
černá

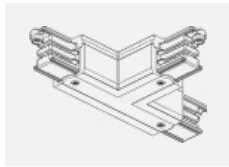

**XTS40-3, white**  
spojka T vnitřní pravá,  
bílá

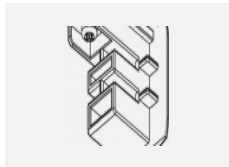

**XTS41-1, grey**  
koncovka, šedá

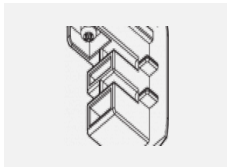

**XTS41-2, black**  
koncovka, černá

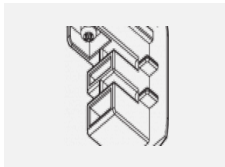

**XTS41-3, white**  
koncovka, bílá

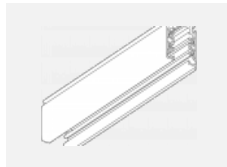

**XTS4100-1, grey**  
lišta 1m, šedá

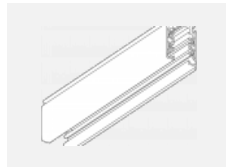

**XTS4100-2, black**  
lišta 1m, černá



**XTS4100-3, white**  
lišta 1m, bílá



**XTS4200-1, grey**  
lišta 2m, šedá



**XTS4200-2, black**  
lišta 2m, černá



**XTS4200-3, white**  
lišta 2m, bílá

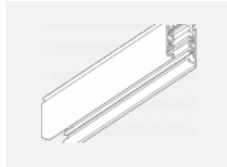

**XTS4300-1, grey**  
lišta 3m, šedá

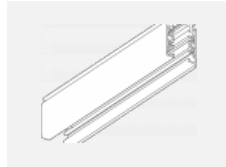

**XTS4300-2, black**  
lišta 3m, černá



**XTS4300-3, white**  
lišta 3m, bílá



**XTS4400-1, grey**  
lišta 4m, šedá



**XTS4400-2, black**  
lišta 4m, černá



**XTS4400-3, white**  
lišta 4m, bílá

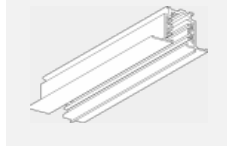

**XTSF4100-1, grey**  
lišta 1m - zapuštěná  
montáž, šedá

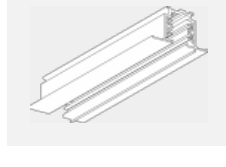

**XTSF4100-2, black**  
lišta 1m - zapuštěná  
montáž, černá

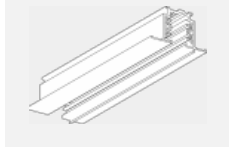

**XTSF4100-3, white**  
lišta 1m - zapuštěná  
montáž, bílá

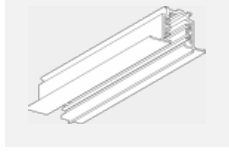

**XTSF4200-1, grey**  
lišta 2m - zapuštěná  
montáž, šedá

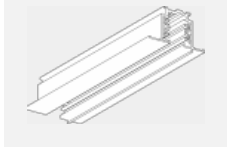

**XTSF4200-2, black**  
lišta 2m - zapuštěná  
montáž, černá

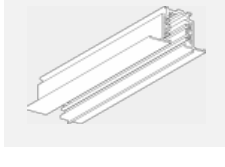

**XTSF4200-3, white**  
lišta 2m - zapuštěná  
montáž, bílá

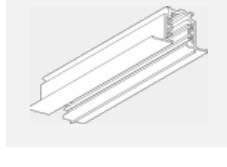

**XTSF4300-1, grey**  
lišta 3m - zapuštěná  
montáž, šedá

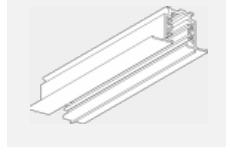

**XTSF4300-2, black**  
lišta 3m - zapuštěná  
montáž, černá



**XTSF4300-3, white**  
lišta 3m - zapuštěná  
montáž, bílá



**XTSF4400-1, grey**  
lišta 4m - zapuštěná  
montáž, šedá



**XTSF4400-2, black**  
lišta 4m - zapuštěná  
montáž, černá



**XTSF4400-3, white**  
lišta 4m - zapuštěná  
montáž, bílá



**XTSV12-1, grey**  
nástroj na ohýbání  
vodičů