



## Svítidlo

# Sant-T

132-600K-25GED/830, W

 reddit award 2015  
winner

Holandský designér Rob van Beek vdechl LED lineárnímu svítidlu s opálovým difusorem světový vzhled. V Čechách jsme pak Sant vyrobili speciálně pro LED zdroje a technologii Human Centric Lighting. Svítidlo Sant-T je vhodné především jako doplňkové osvětlení do obchodních prostor.

Design Rob van Beek

## Technický výkres

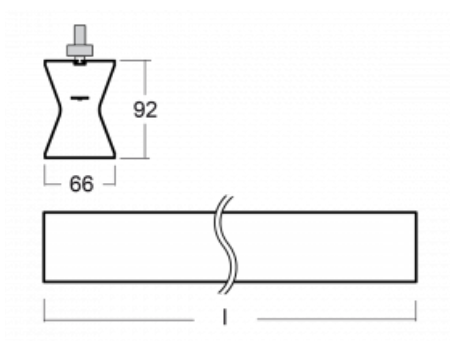

Typ montáže	Lištové
Typ vyzařování	Přímo-nepřímé
Tvar svítidla	Lineární
Barva svítidla	Bílá
Materiál	Hliník
Životnost	L80/B20 50 000 hodin
Záruka	5 let
Popis svítidla	Svítidlo lištové
Rozměry	1410 mm × 66 mm × 92 mm
Světelný zdroj	LED MODUL
Druh optiky	Opálový difusor
Světelný tok*	2630 lm
Teplota chromatičnosti	3000 K teplá bílá
Měrný výkon	110 lm/W
MacAdam zdroje	3
Index podání barev	80
UGR max. X=4H Y=8H, ρ=70,50,20	21.8
Příkon svítidla*	24 W
Zapojení svítidla	DALI
Elektrické napětí	220-240V
Frekvence	50/60Hz

 CE IP 20

\*±10 %

# Křivka



**Ke stažení**[Montážní návod](#)[Fotografie](#)

**Příslušenství**

**00-00300, N**  
 lankový závěs 2000mm  
 -1 ks

**00-00301, N**  
 lankový závěs 4000mm  
 -1 ks

**00-00302, N**  
 lankový závěs 6000mm  
 -1 ks

**00-00363, K**  
 kabel 5x1,5 2000mm

**00-00364, K**  
 kabel 5x1,5 4000mm

**00-00365, K**  
 kabel 5x1,5 6000mm

**00-00370, B**  
 kalíšek stropní  
 80x80x32mm

**00-00370, S**  
 kalíšek stropní  
 80x80x32mm

**00-00370, W**  
 kalíšek stropní  
 80x80x32mm

**SKB10-1, grey**  
 stropní úchyt pro lištu,  
 šedá

**SKB10-2, black**  
 stropní úchyt pro lištu,  
 černá

**SKB10-3, white**  
 stropní úchyt pro lištu,  
 bílá

**SKB12-1, grey**  
 úchyt do lišty pro  
 lanový závěs, šedá

**SKB12-2, black**  
 úchyt do lišty pro  
 lanový závěs, černá

**SKB12-3, white**  
 úchyt do lišty pro  
 lanový závěs, bílá

**XTAK11-1, grey**  
 háček, šedá

**XTAK142-1, grey**  
 základna háčku, šedá

**XTAK142-2, black**  
 základna háčku, černá

**XTAK142-3, white**  
 základna háčku lanko  
 2mm, bílá

**XTS41-1, grey**  
 koncovka, šedá

**XTS41-2, black**  
 koncovka, černá

**XTS41-3, white**  
 koncovka, bílá

**XTSC6100-1, grey**  
 lišta 1m, DALI, šedá

**XTSC6100-2, black**  
 lišta 1m, DALI, černá

**XTSC6100-3, white**  
 lišta 1m, DALI, bílá

**XTSC611-1, grey**  
 koncové napájení levé,  
 DALI, šedá

**XTSC611-2, black**  
 koncové napájení levé,  
 DALI, černá

**XTSC611-3, white**  
 koncové napájení levé,  
 DALI, bílá

**XTSC612-1, grey**  
 koncové napájení pravé,  
 DALI, šedá

**XTSC612-2, black**  
 koncové napájení pravé,  
 DALI, černá

**XTSC612-3, white**  
 koncové napájení pravé,  
 DALI, bílá

**XTSC614-1, grey**  
 napájení středové, DALI,  
 šedá

**XTSC614-2, black**  
 napájení středové, DALI,  
 černá

**XTSC614-3, white**  
 napájení středové, DALI,  
 bílá

**XTSC6200-1, grey**  
 lišta 2m, DALI, šedá

**XTSC6200-2, black**  
 lišta 2m, DALI, černá



**XTSC6200-3, white**  
lišta 2m, DALI, bílá

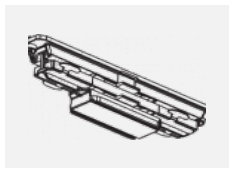

**XTSC621-1, grey**  
spojka přímá, DALI, šedá

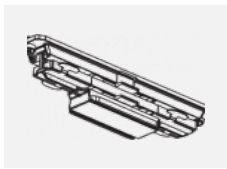

**XTSC621-2, black**  
spojka přímá, DALI, černá

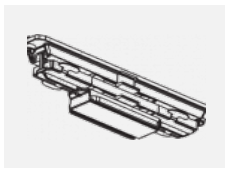

**XTSC621-3, white**  
spojka přímá, DALI, bílá

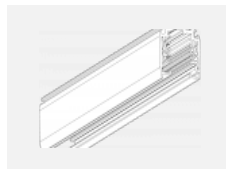

**XTSC6300-1, grey**  
lišta 3m, DALI, šedá

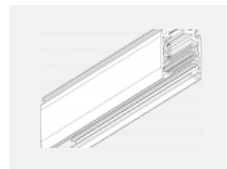

**XTSC6300-2, black**  
lišta 3m, DALI, černá



**XTSC6300-3, white**  
lišta 3m, DALI, bílá

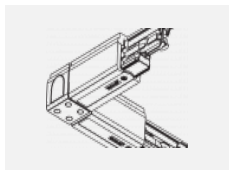

**XTSC634-1, grey**  
spojka L vnitřní, DALI, šedá

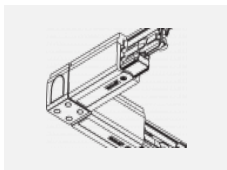

**XTSC634-2, black**  
spojka L vnitřní, DALI, černá

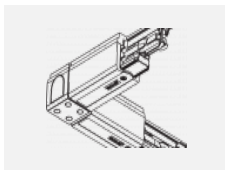

**XTSC634-3, white**  
spojka L vnitřní, DALI, bílá

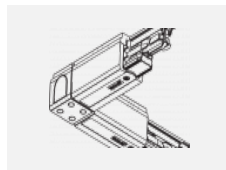

**XTSC635-1, grey**  
spojka L vnější, DALI, šedá

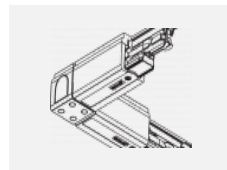

**XTSC635-2, black**  
spojka L vnější, DALI, černá



**XTSC635-3, white**  
spojka L vnější, DALI, bílá



**XTSC636-2, black**  
spojka T vnější pravá, DALI, černá



**XTSC636-3, white**  
spojka T vnější pravá, DALI, bílá



**XTSC637-1, grey**  
spojka T vnitřní levá, DALI, šedá



**XTSC637-2, black**  
spojka T vnitřní levá, DALI, černá

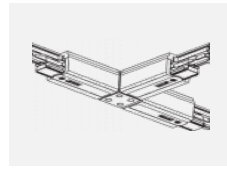

**XTSC637-3, white**  
spojka T vnitřní levá, DALI, bílá



**XTSC638-1, grey**  
spojka X, DALI, šedá



**XTSC638-2, black**  
spojka X, DALI, černá



**XTSC638-3, white**  
spojka X, DALI, bílá



**XTSC639-1, grey**  
spojka T vnější levá, DALI, šedá



**XTSC639-2, black**  
spojka T vnější levá, DALI, černá

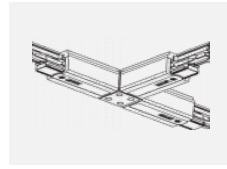

**XTSC639-3, white**  
spojka T vnější levá, DALI, bílá



**XTSC640-1, grey**  
spojka T vnitřní pravá, DALI, šedá



**XTSC640-2, black**  
spojka T vnitřní pravá, DALI, černá



**XTSC640-3, white**  
spojka T vnitřní pravá, DALI, bílá



**XTSC6400-1, grey**  
lišta 4m, DALI, šedá



**XTSC6400-2, black**  
lišta 4m, DALI, černá

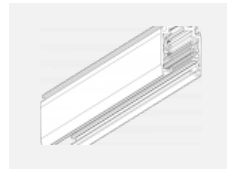

**XTSC6400-3, white**  
lišta 4m, DALI, bílá



**XTSCF6100-1, grey**  
lišta 1m, DALI -  
zapuštěná montáž, šedá



**XTSCF6100-2, black**  
lišta 1m, DALI -  
zapuštěná montáž, černá



**XTSCF6100-3, white**  
lišta 1m, DALI -  
zapuštěná montáž, bílá



**XTSCF6200-1, grey**  
lišta 2m, DALI -  
zapuštěná montáž, šedá



**XTSCF6200-2, black**  
lišta 2m, DALI -  
zapuštěná montáž, černá



**XTSCF6200-3, white**  
lišta 2m, DALI -  
zapuštěná montáž, bílá



**XTSCF6300-1, grey**  
lišta 3m, DALI -  
zapuštěná montáž, šedá



**XTSCF6300-2, black**  
lišta 3m, DALI -  
zapuštěná montáž, černá



**XTSCF6300-3, white**  
lišta 3m, DALI -  
zapuštěná montáž, bílá



**XTSCF6400-1, grey**  
lišta 4m, DALI -  
zapuštěná montáž, šedá



**XTSCF6400-2, black**  
lišta 4m, DALI -  
zapuštěná montáž, černá



**XTSCF6400-3, white**  
lišta 4m, DALI -  
zapuštěná montáž, bílá



**XTSV12-1, grey**  
nástroj na ohýbání  
vodičů