



Svítidlo

Sant-T

132-600K-20GGE/830, B



Holandský designér Rob van Beek vdechl LED lineárnímu svítidlu s opálovým difusorem světový vzhled. V Čechách jsme pak Sant vyrobili speciálně pro LED zdroje a technologii Human Centric Lighting. Svítidlo Sant-T je vhodné především jako doplňkové osvětlení do obchodních prostor.

Design Rob van Beek

Technický výkres

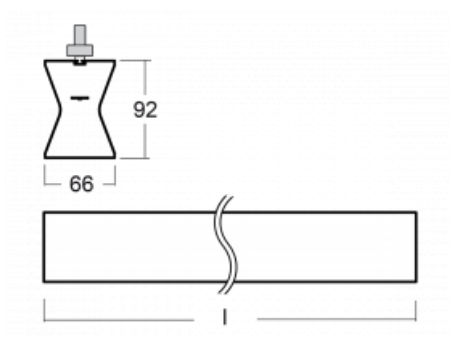

| | |
|-----------------------------------|--------------------------|
| Typ montáže | Lištové |
| Typ vyzařování | Přímo-nepřímé |
| Tvar svítidla | Lineární |
| Barva svítidla | Černá |
| Materiál | Hliník |
| Životnost | L80/B20 50 000 hodin |
| Záruka | 60 měsíců |
| Popis svítidla | Svítidlo lištové |
| Rozměry | 1130 mm × 66 mm × 92 mm |
| Hmotnost | 3.1 kg |
| Světelný zdroj | LED MODUL |
| Druh optiky | Opálový difusor |
| Světelný tok* | 3400 lm ± 10 % |
| Teplota chromatičnosti | 3000 K teplá bílá |
| Měrný výkon | 97 lm/W |
| MacAdam zdroje | 3 |
| Index podání barev | 80 |
| UGR max. X=4H Y=8H, ρ=70,50,20 | 23.5 |
| Příkon svítidla | 34.9 W ± 10 % |
| Zapojení svítidla | Předradník nestmívatelný |
| Elektrické napětí | 220-240V |
| Frekvence | 50/60Hz |



Křivka



Ke stažení

Montážní návod



Fotografie



Příslušenství

00-00300, N
 lankový závěs 2000mm
 -1 ks

00-00301, N
 lankový závěs 4000mm
 -1 ks

00-00302, N
 lankový závěs 6000mm
 -1 ks

00-00363, K
 kabel 5x1,5 2000mm

00-00364, K
 kabel 5x1,5 4000mm

00-00365, K
 kabel 5x1,5 6000mm

00-00370, B
 kališek stropní
 80x80x32mm

00-00370, S
 kališek stropní
 80x80x32mm

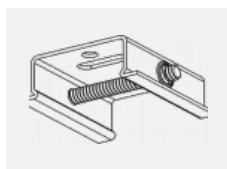
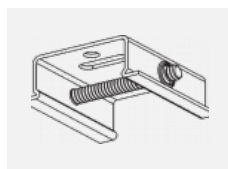
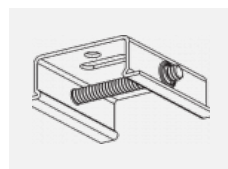
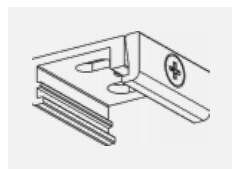
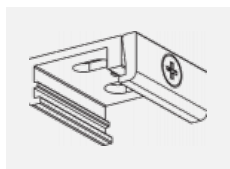
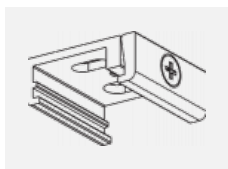
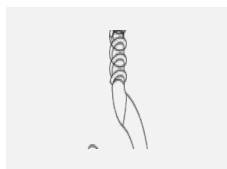
00-00370, W
 kališek stropní
 80x80x32mm

SKB10-1, grey
 stropní úchyt pro lištu,
 šedá

SKB10-2, black
 stropní úchyt pro lištu,
 černá

SKB10-3, white
 stropní úchyt pro lištu,
 bílá

SKB12-1, grey
 úchyt do lišty pro
 lankový závěs, šedá

SKB12-2, black
 úchyt do lišty pro
 lankový závěs, černá

SKB12-3, white
 úchyt do lišty pro
 lankový závěs, bílá

XTAK11-1, grey
 háček, šedá

XTAK142-1, grey
 základna háčku, šedá

XTAK142-2, black
 základna háčku, černá

XTAK142-3, white
 základna háčku lanko
 2mm, bílá

XTS11-1, grey
 koncové napájení levé,
 šedá

XTS11-2, black
 koncové napájení levé,
 černá

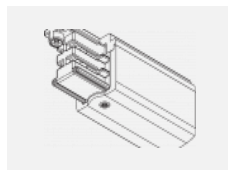
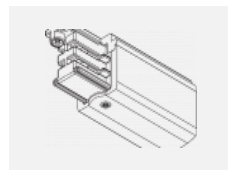
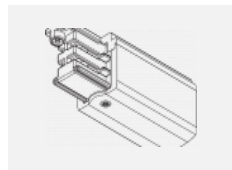
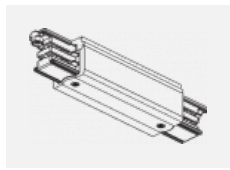
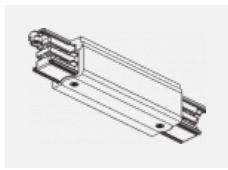
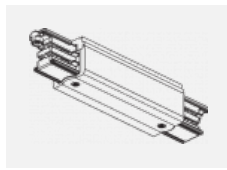
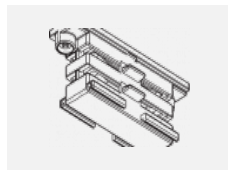
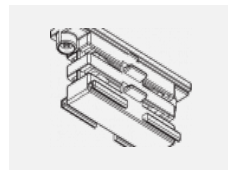
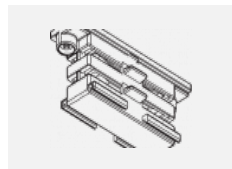
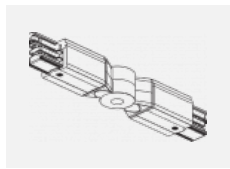
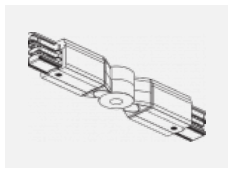
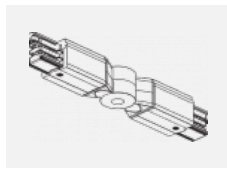
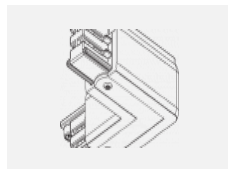
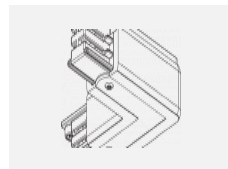
XTS11-3, white
 koncové napájení levé,
 bílá

XTS12-1, grey
 koncové napájení pravé,
 šedá

XTS12-2, black
 koncové napájení pravé,
 černá

XTS12-3, white
 koncové napájení pravé,
 bílá

XTS14-1, grey
 napájení středové, šedá

XTS14-2, black
 napájení středové, černá

XTS14-3, white
 napájení středové, bílá

XTS21-1, grey
 spojka přímá, šedá

XTS21-2, black
 spojka přímá, černá

XTS21-3, white
 spojka přímá, bílá

XTS24-1, grey
 spojka ohebná kloubová,
 šedá

XTS24-2, black
 spojka ohebná kloubová,
 černá

XTS24-3, white
 spojka ohebná kloubová,
 bílá

XTS34-1, grey
 spojka L vnitřní, šedá

XTS34-2, black
 spojka L vnitřní, černá



XTS34-3, white
spojka L vnitřní, bílá



XTS35-1, grey
spojka L vnější, šedá



XTS35-2, black
spojka L vnější, černá



XTS35-3, white
spojka L vnější, bílá



XTS36-1, grey
spojka T vnější pravá,
šedá



XTS36-2, black
spojka T vnější pravá,
černá



XTS36-3, white
spojka T vnější pravá,
bílá



XTS37-1, grey
spojka T vnitřní levá,
šedá



XTS37-2, black
spojka T vnitřní levá,
černá



XTS37-3, white
spojka T vnitřní levá, bílá



XTS38-1, grey
spojka X, šedá



XTS38-2, black
spojka X, černá



XTS38-3, white
spojka X, bílá



XTS39-1, grey
spojka T vnější levá,
šedá



XTS39-2, black
spojka T vnější levá,
černá



XTS39-3, white
spojka T vnější levá, bílá



XTS40-1, grey
spojka T vnitřní pravá,
šedá



XTS40-2, black
spojka T vnitřní pravá,
černá



XTS40-3, white
spojka T vnitřní pravá,
bílá



XTS41-1, grey
koncovka, šedá



XTS41-2, black
koncovka, černá



XTS41-3, white
koncovka, bílá



XTS4100-1, grey
lišta 1m, šedá



XTS4100-2, black
lišta 1m, černá



XTS4100-3, white
lišta 1m, bílá



XTS4200-1, grey
lišta 2m, šedá



XTS4200-2, black
lišta 2m, černá



XTS4200-3, white
lišta 2m, bílá



XTS4300-1, grey
lišta 3m, šedá



XTS4300-2, black
lišta 3m, černá



XTS4300-3, white
lišta 3m, bílá



XTS4400-1, grey
lišta 4m, šedá



XTS4400-2, black
lišta 4m, černá



XTS4400-3, white
lišta 4m, bílá



XTSF4100-1, grey
lišta 1m - zapuštěná
montáž, šedá



XTSF4100-2, black
lišta 1m - zapuštěná
montáž, černá

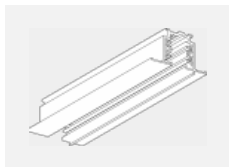

XTSF4100-3, white
lišta 1m - zapuštěná
montáž, bílá

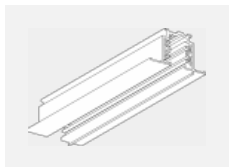

XTSF4200-1, grey
lišta 2m - zapuštěná
montáž, šedá

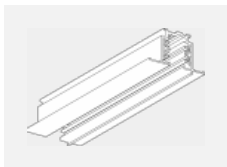

XTSF4200-2, black
lišta 2m - zapuštěná
montáž, černá

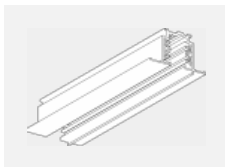

XTSF4200-3, white
lišta 2m - zapuštěná
montáž, bílá

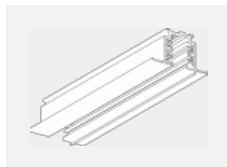

XTSF4300-1, grey
lišta 3m - zapuštěná
montáž, šedá

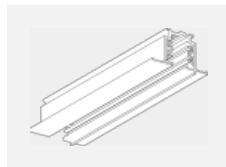

XTSF4300-2, black
lišta 3m - zapuštěná
montáž, černá



XTSF4300-3, white
lišta 3m - zapuštěná
montáž, bílá



XTSF4400-1, grey
lišta 4m - zapuštěná
montáž, šedá



XTSF4400-2, black
lišta 4m - zapuštěná
montáž, černá



XTSF4400-3, white
lišta 4m - zapuštěná
montáž, bílá



XTSV12-1, grey
nástroj na ohýbání
vodičů